

R-18



え
おんば
ねが
が
い
し
ま
す
さん





俺は24年間の童貞を
捨てるべく
願いが叶うという
円盤の町にやってきた



円盤さんお願いします
幼女とえっちさせてください

お兄さんがノエルを
呼んだの？

なるほど

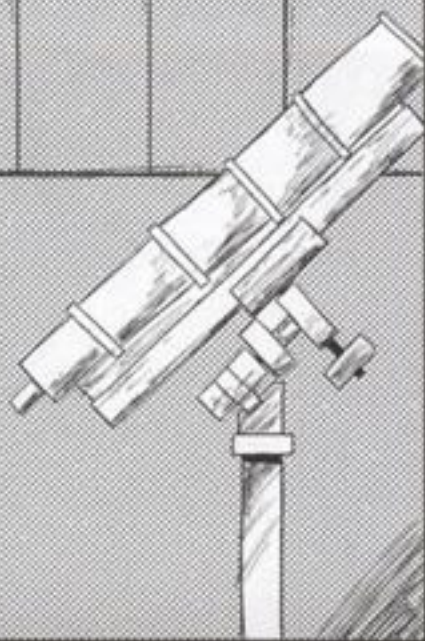

ノエルが
お兄さんをにっこりに
してあげる！



ノエルちゃんは
願いを叶えるため
に来てくれたんだね



うまく舐めると
おいしい汁が出るんだ

っん

っん

これなに？

？

それじゃ
これを舐めてもらおうかな

すっん









ほんとは
甘い……
けど、変な味



糖尿病かな？



ノエルちゃん？



お兄さん
ノエルね……
……おかしこの……

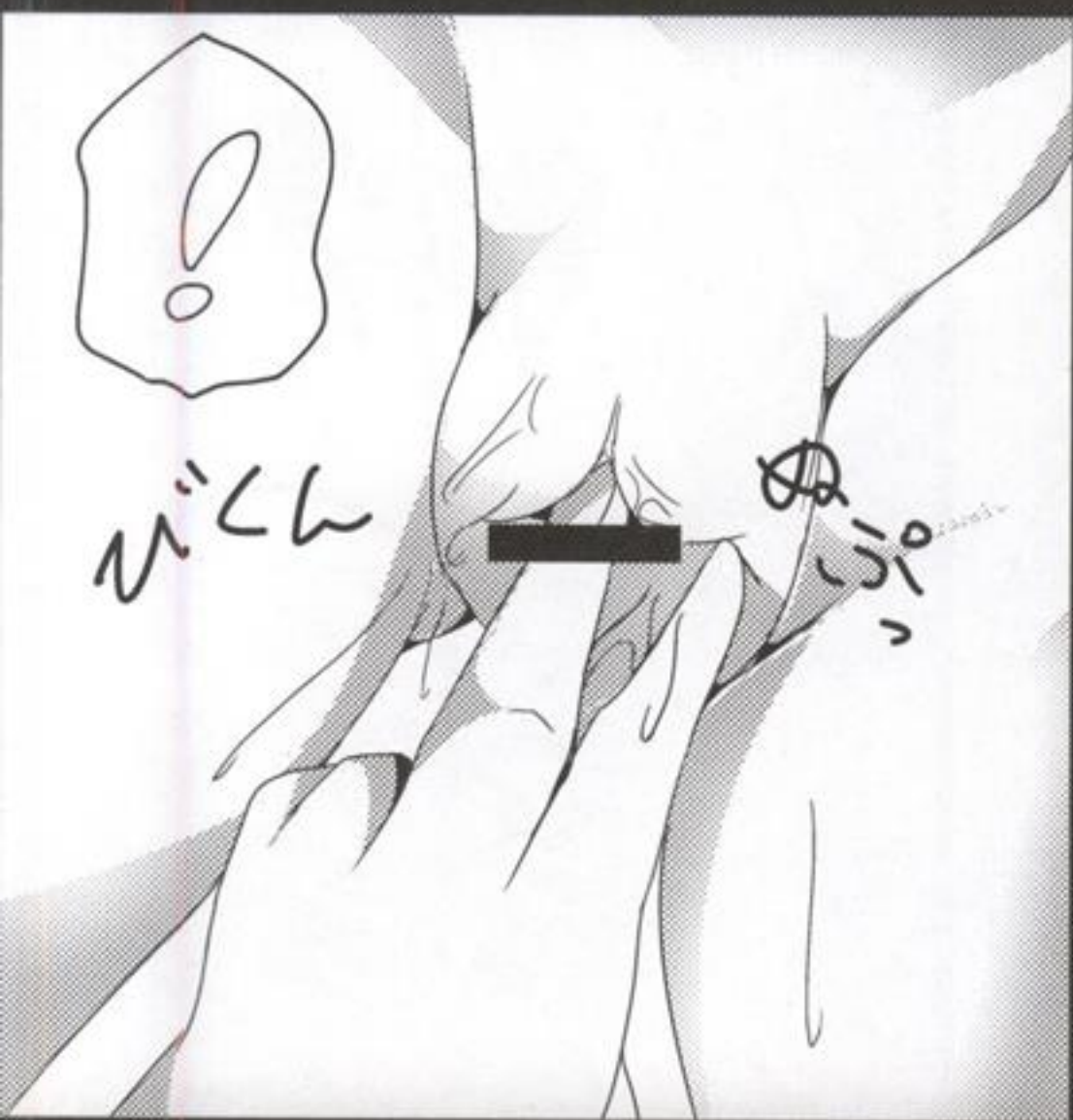

びん

びん



びしょびしょだ……
何もしてないのに
これも円盤の力？

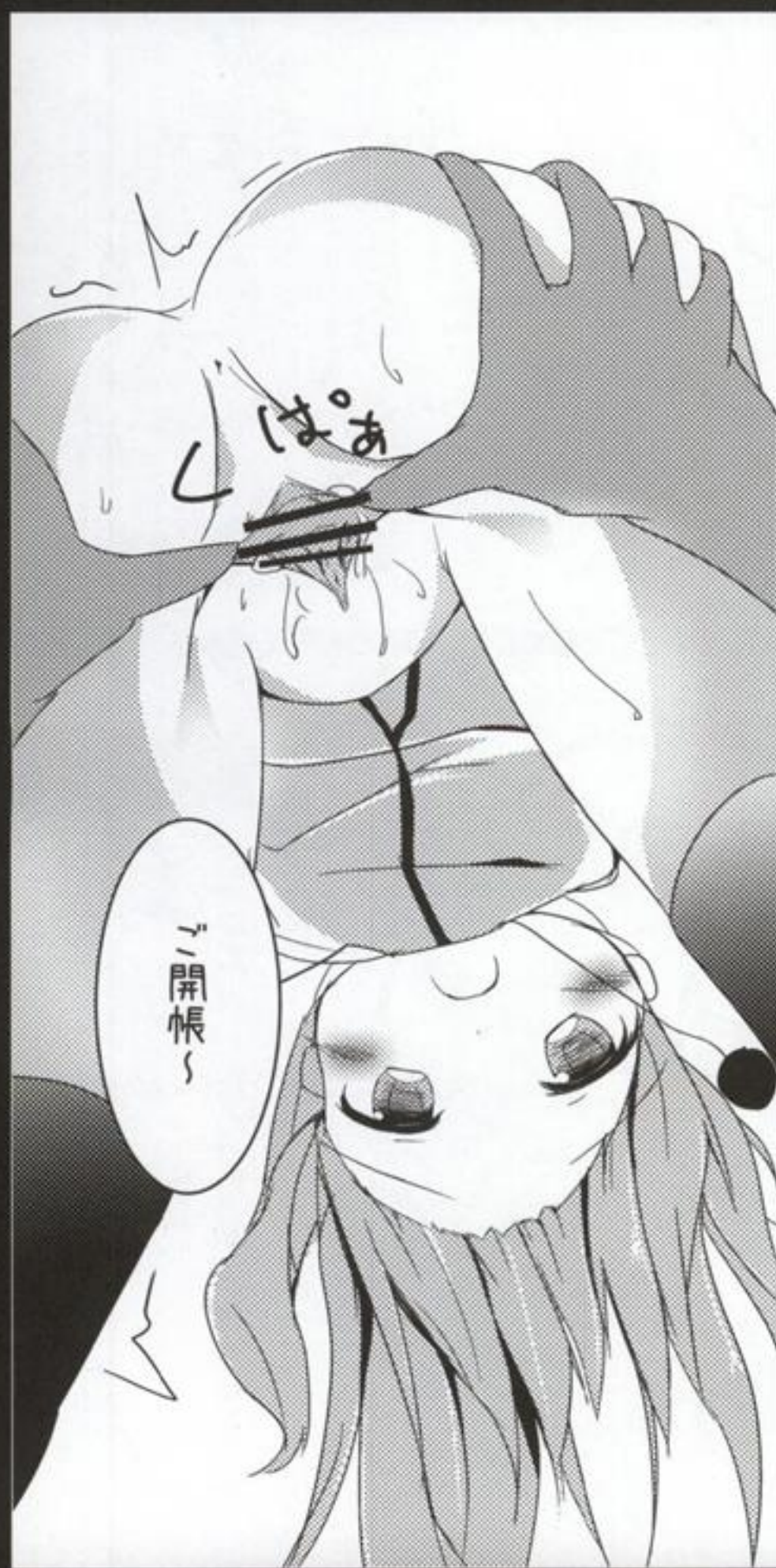

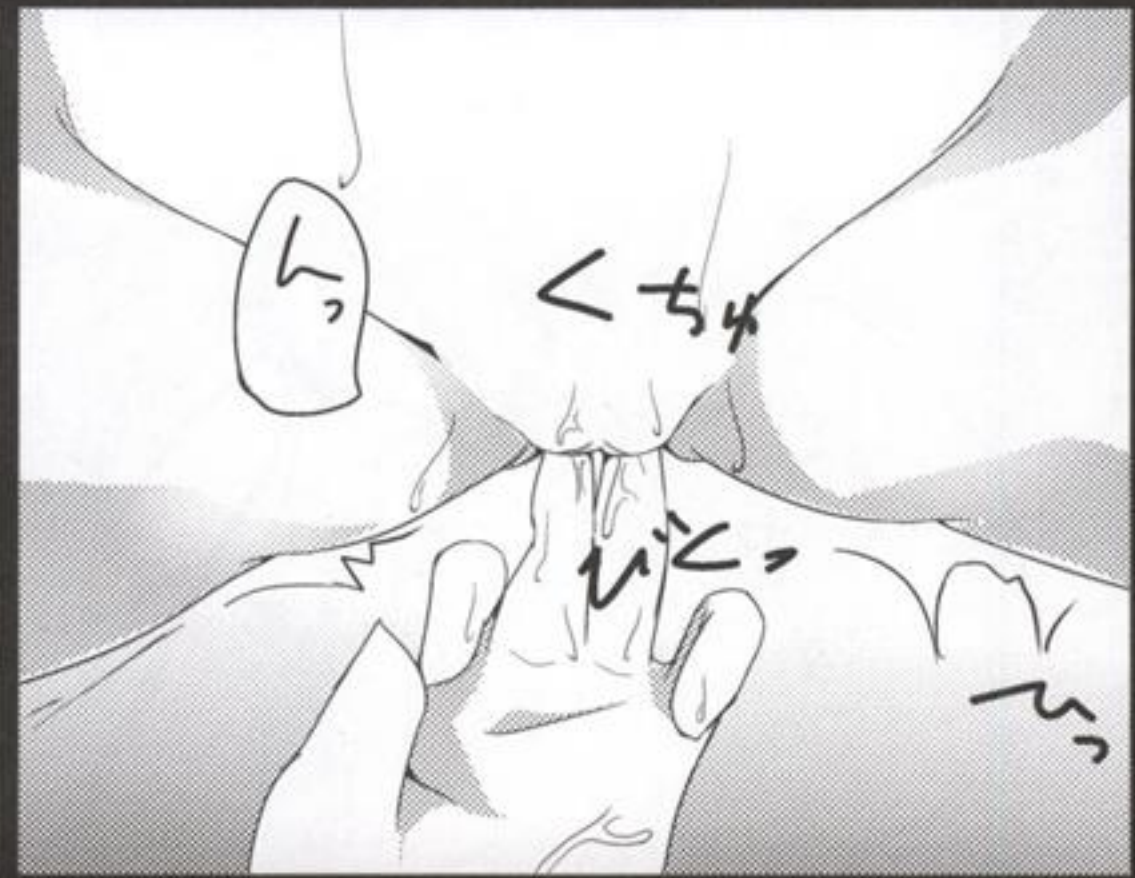



それじゃ、
本番いこうか

本番？



につこりに
必要なことなんだ

これでお兄さんっ
につこりになれる？

っっっ
！

おっっっ

おっ

おっ

おっ

おっ



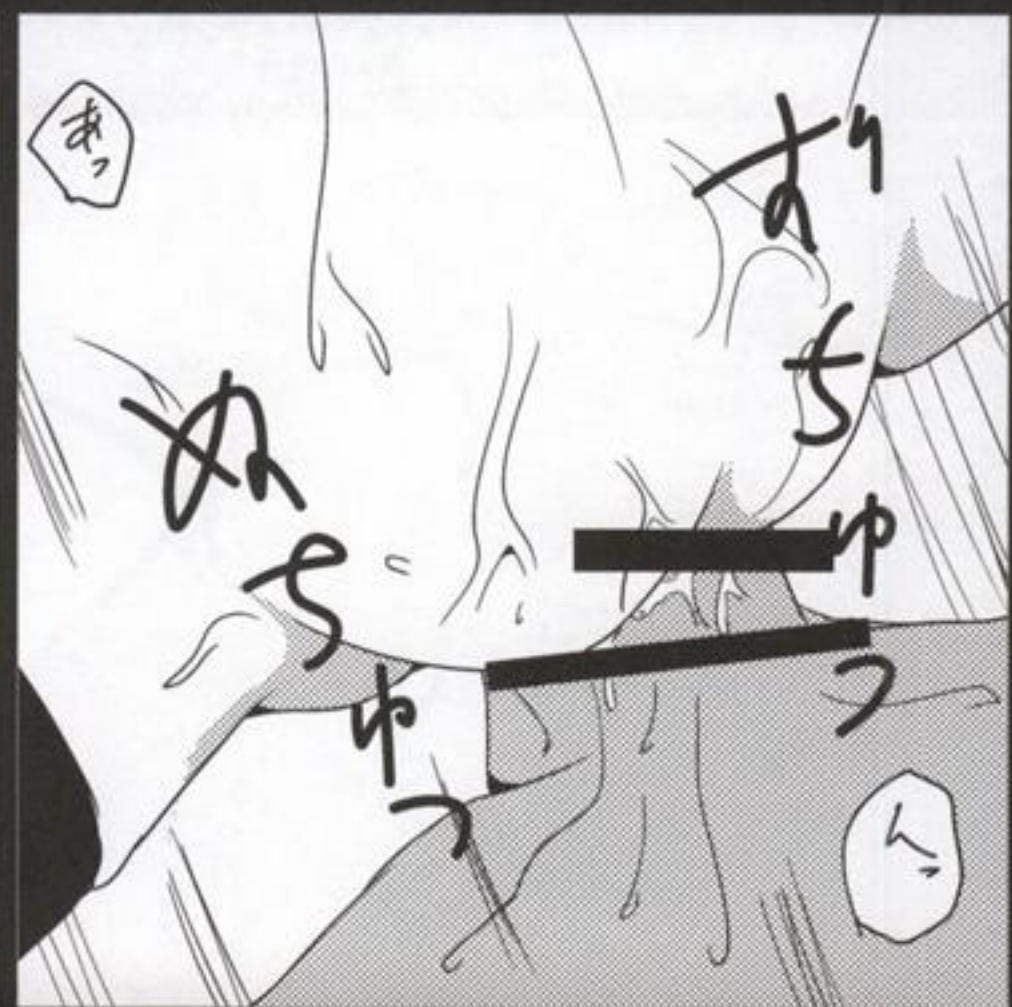



とーさん...

うあめ♡
びる♡♡

びく

みゅ

あ

みゅ

びく

みゅ

とーさん

とー

お兄さん...
にっこりになれたかな





天体の

×'...'...

@yuki-nachi





あとリエ
ひなた