

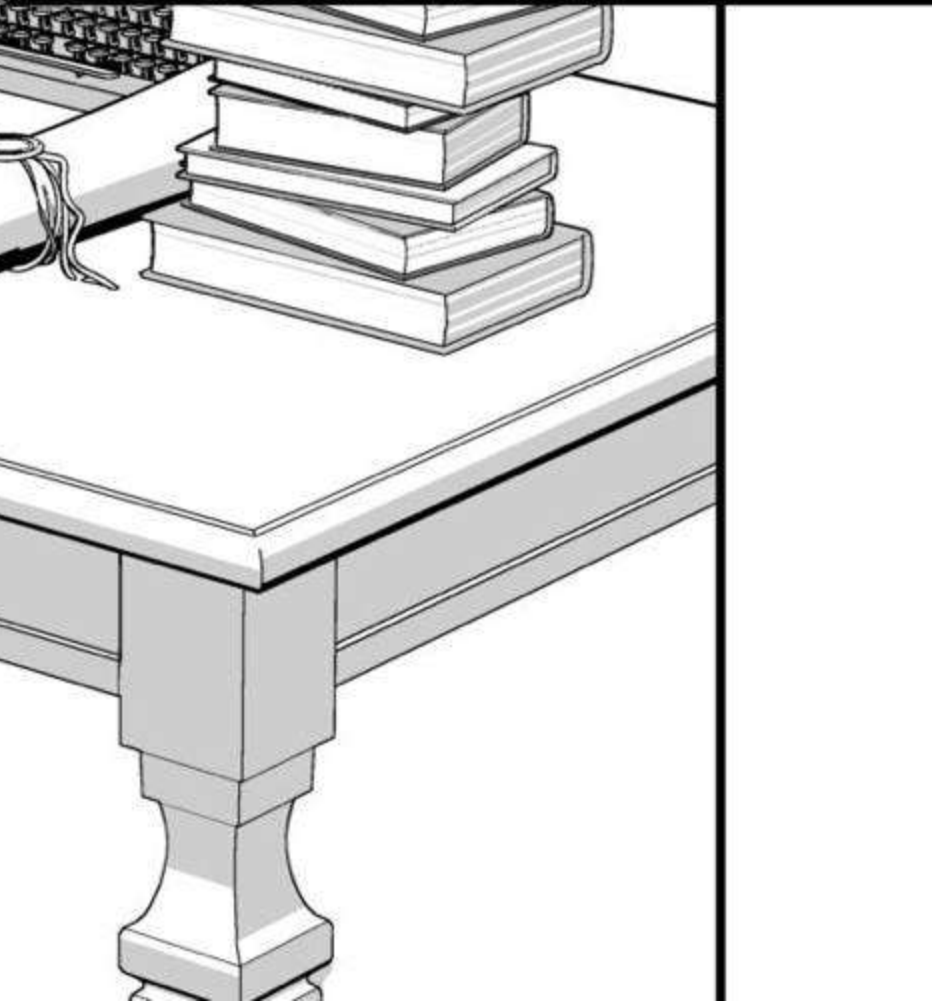

腰
ぱんぱん
も
尻
へ
こ
へ
こ

mona siri
heko heko
koshi
panpan.

DOJIN
R18
成人向け
18歳未満の
購入・閲覧禁止



本に埋もれて
倒れている
彼女を発見した…



おぼろげに
透しはるし
この場所…



一週間前—
久しぶりに
モナを訪ねると

モナ?!



うう…
お騒がせしました…

幸い大事には
至らなかったけど



まだまだ仕事で
忙しい日々が
続くらしいので



モナの看病も兼ね、
しばらく住み込みで

彼女の手伝いを
することになった



どりやら
原稿の区切による
寝不足と

金欠による
空腹が原因らしい…

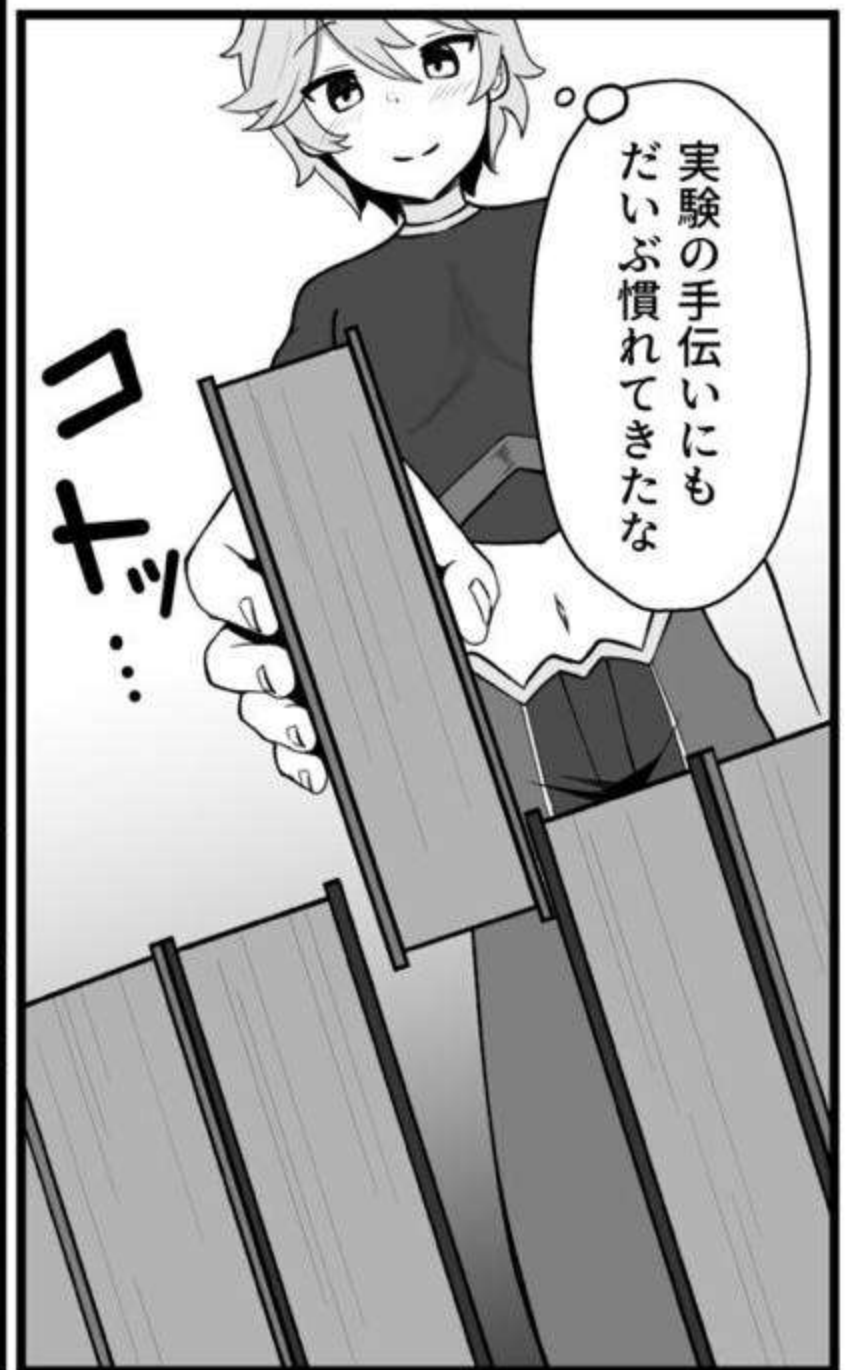





数日前...

旅人?!

!?

ん...?



寝てるからって
気づかないと
思ってたんですか...



ななななにおちんちん
擦り付けてるんですか...?!



モナ... はまっ





あなたには
お世話になって
ますし

何か恩返しを
したいと思って
いたので...

ギン
ゆっ♡



どうですか...



はあ...



このままわたしの
お腹に出して
いいです

フム



苦しいんでしょう?

グッ
グッ



そのまま
ぐりぐりして...

グッ

へっ
へっ



ほら
びゅっ...

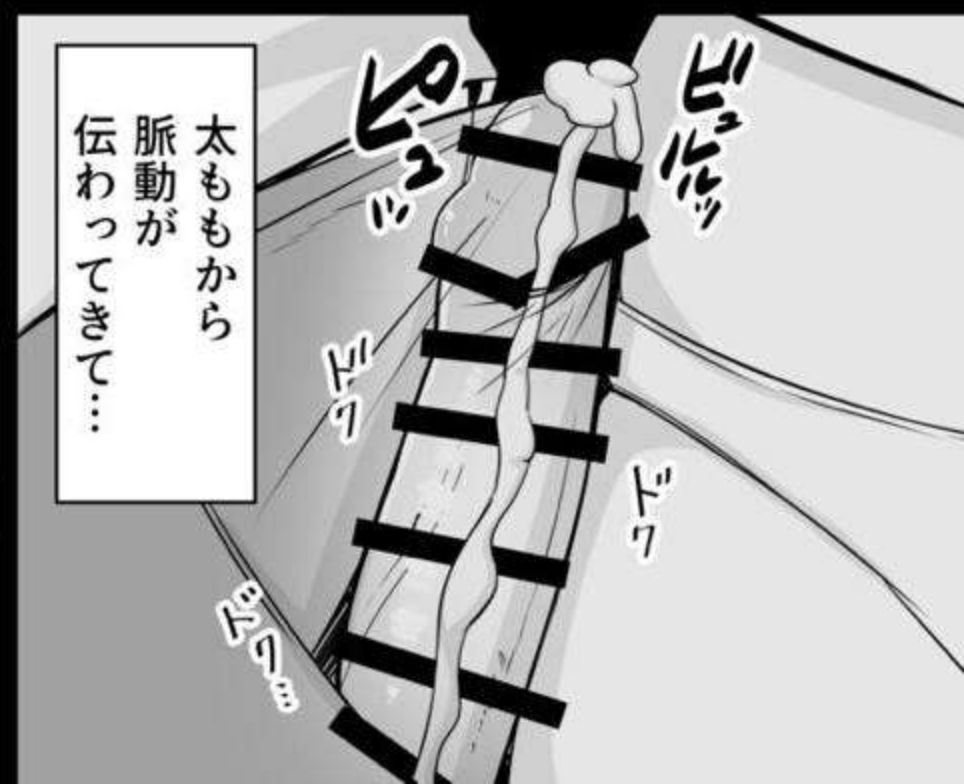



まさか旅人の
性欲がこんな
強いなんて

予想外でした…



あの夜以降
旅人は隙あらば私に
腰をこすり付けて
くるように
なっていました…

カカカカカカ



はあ…
モナのお尻
気持ちいい…

カカカカ



全くしょうが
ないですね

今手が離せないの
そのまま出し
ちゃってください



うう…
もう出ちゃう…

カカカカカカ



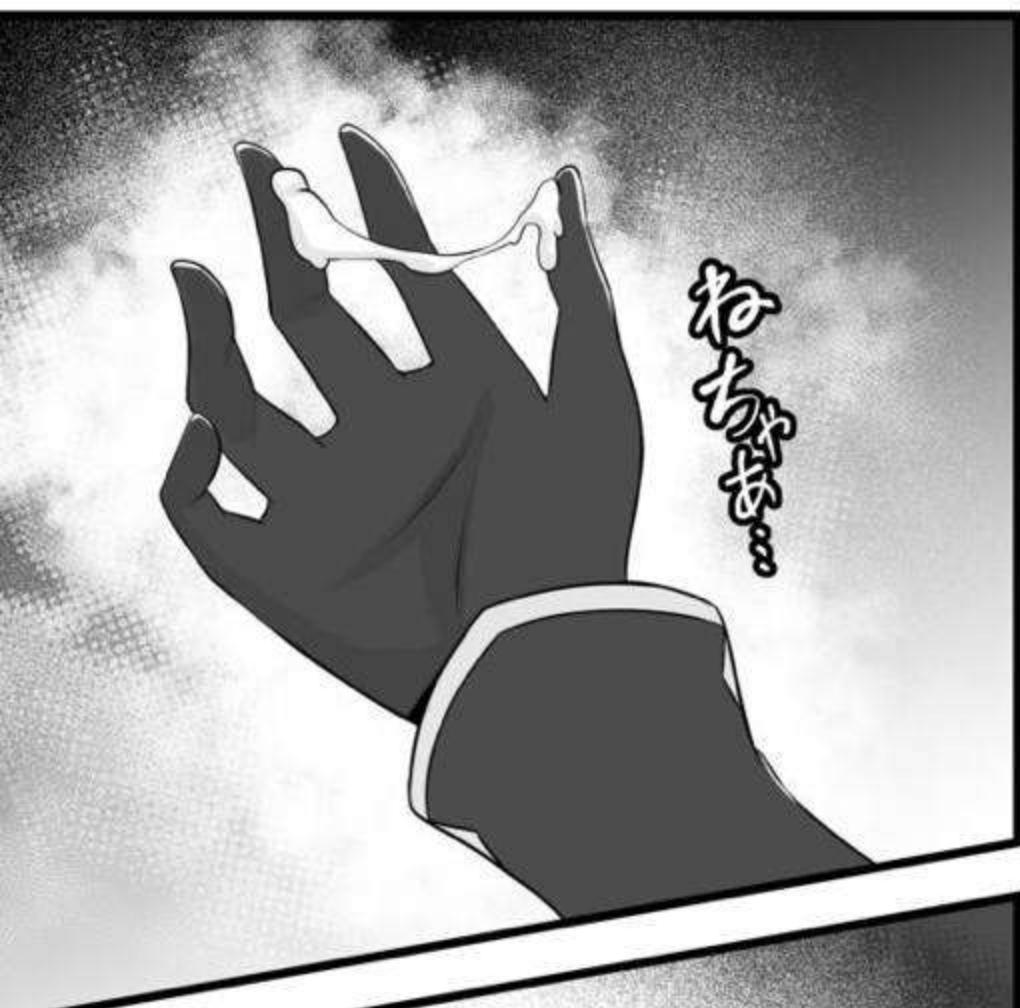







もう本当に
我慢の効かない
人ですね…



こんなのが
本当に気持ち
いいんですか？



おっ
キキキ

ゲリ
ゲリ



精液
押し上げられる…



うぐっ…
尻圧すこ…







顔まで飛んで…
射精しすぎですよ





毎日毎日
へこへこして...
どれだけ
私のお尻好き
なんですか...

まったくもう...
研究も原稿も
全然進まない
じゃないですか...



もう...あんまり
適当なこと
言わないでください...



はぁ...好き...
モナ好き...



ほらどうぞ

ぴゅっぴゅっ...



あっ…
おちんちんの
びくびくすこっ…



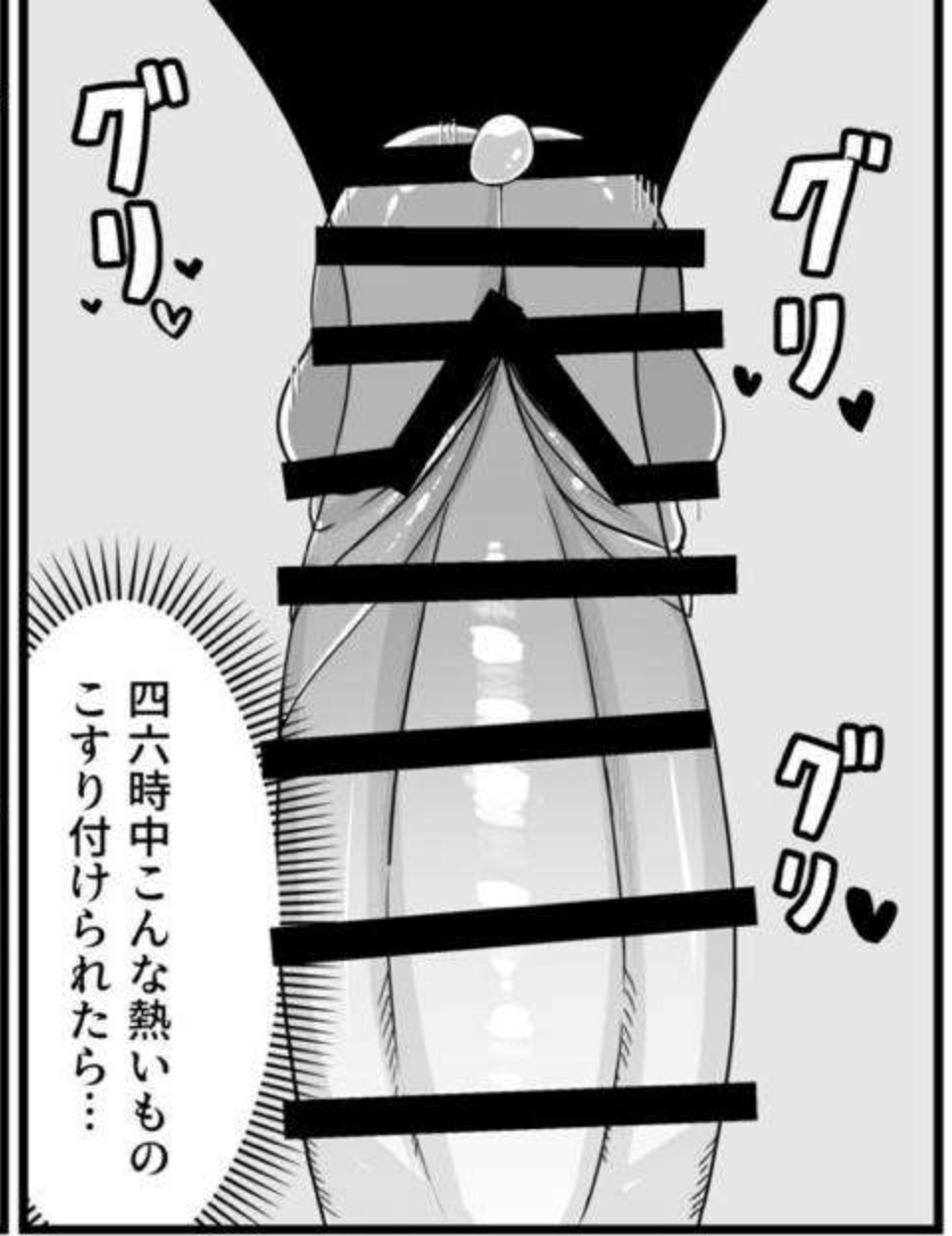

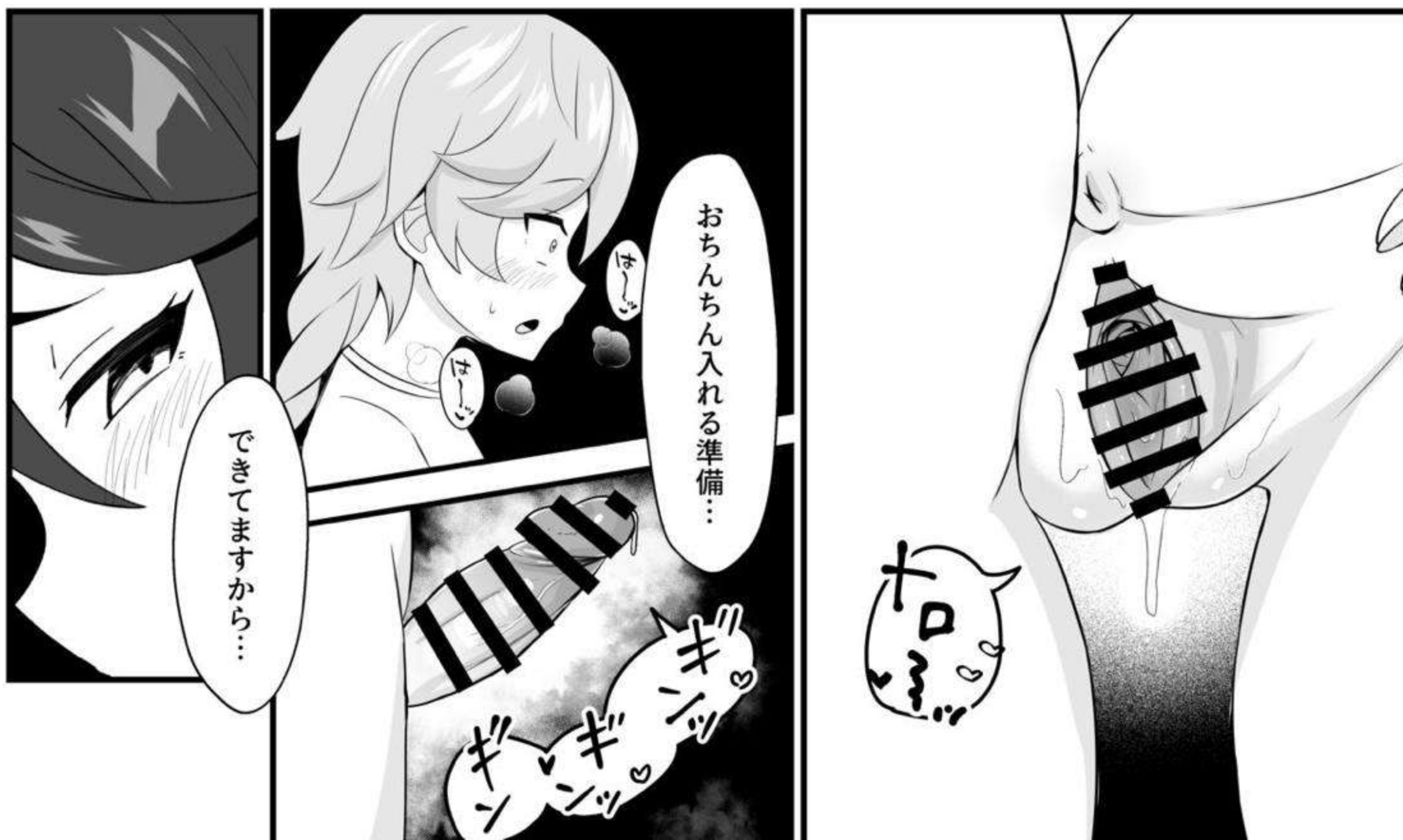

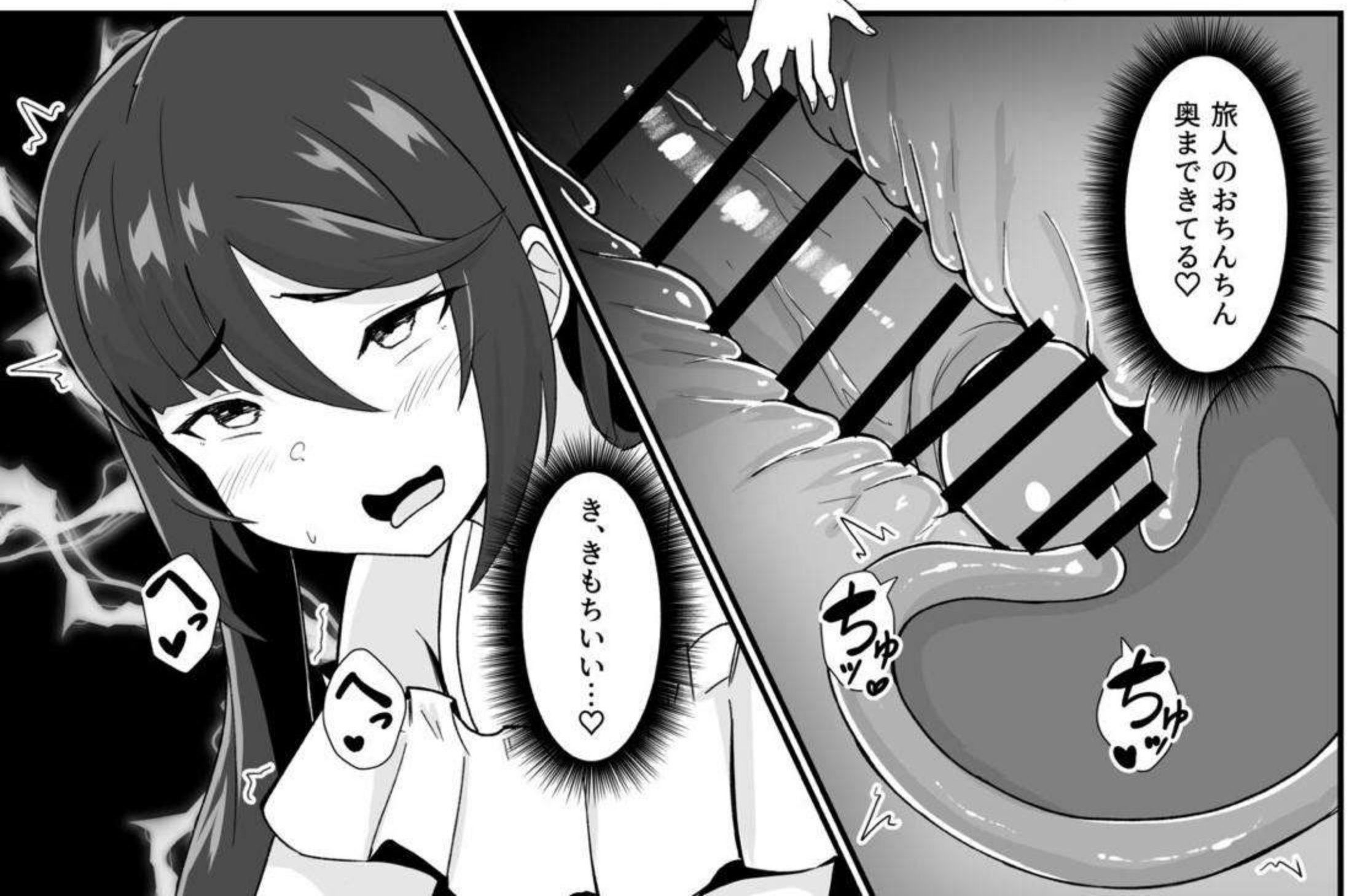



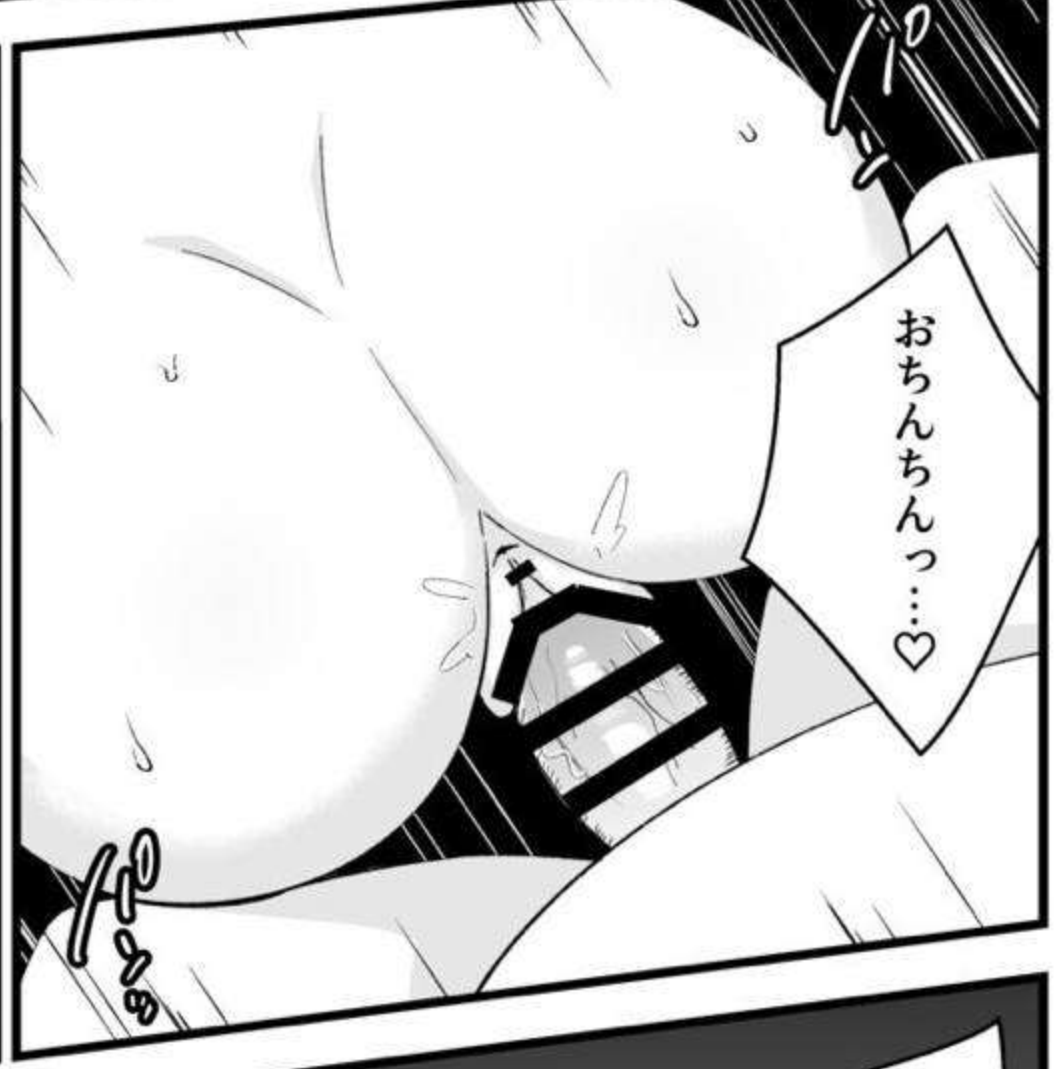
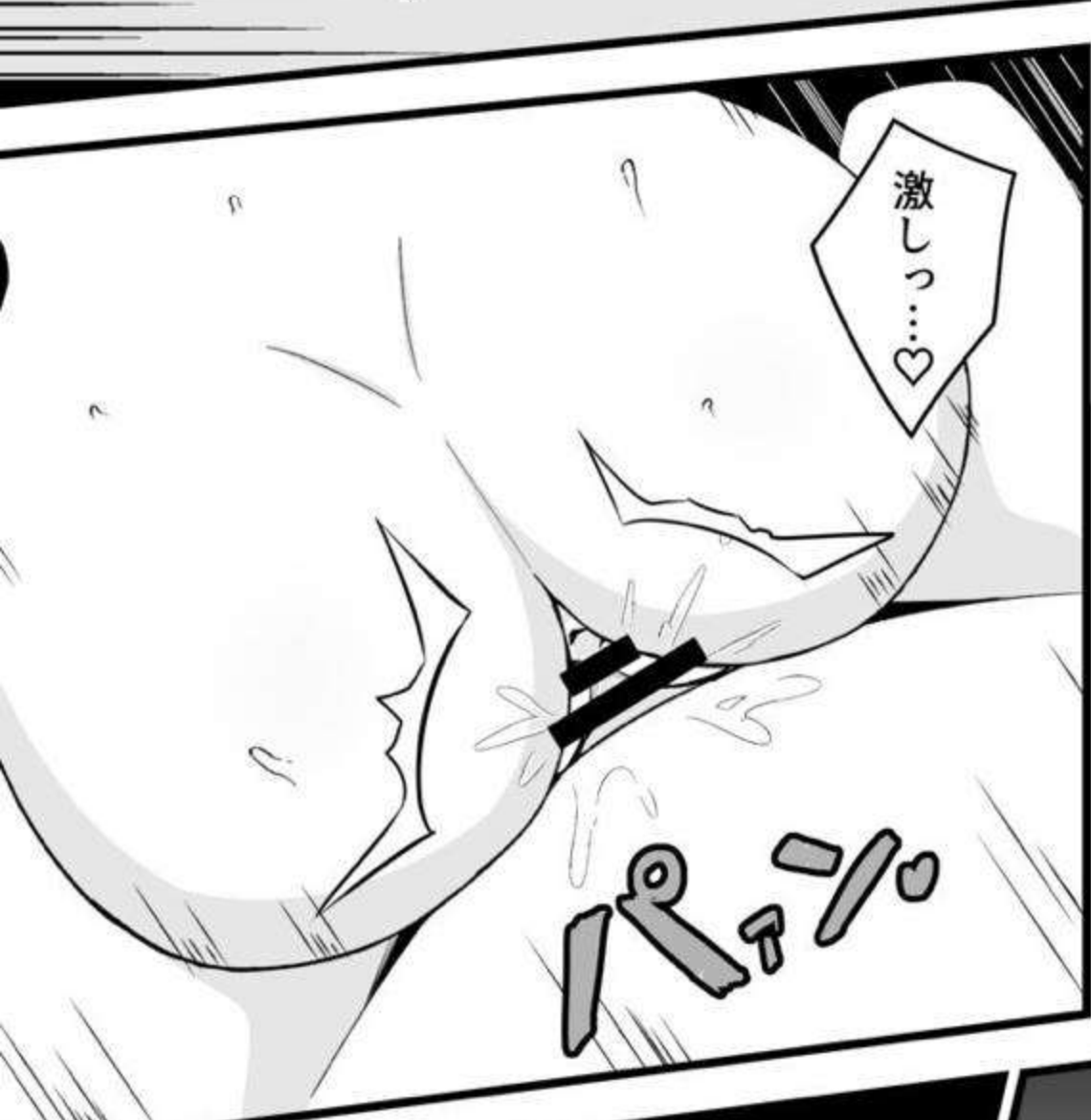
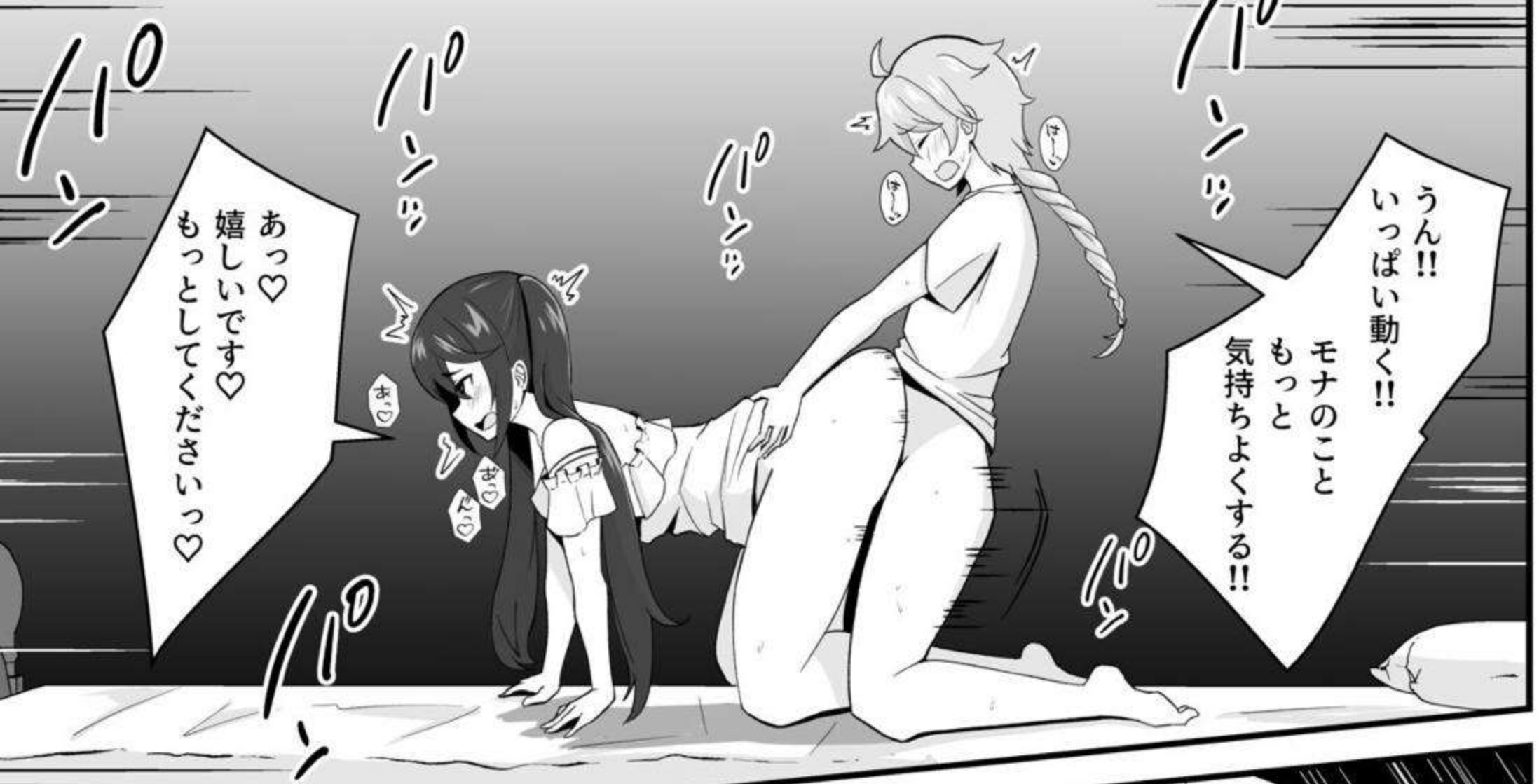



中に射精すよ!!

はあ…モナ…
もう射精る!!

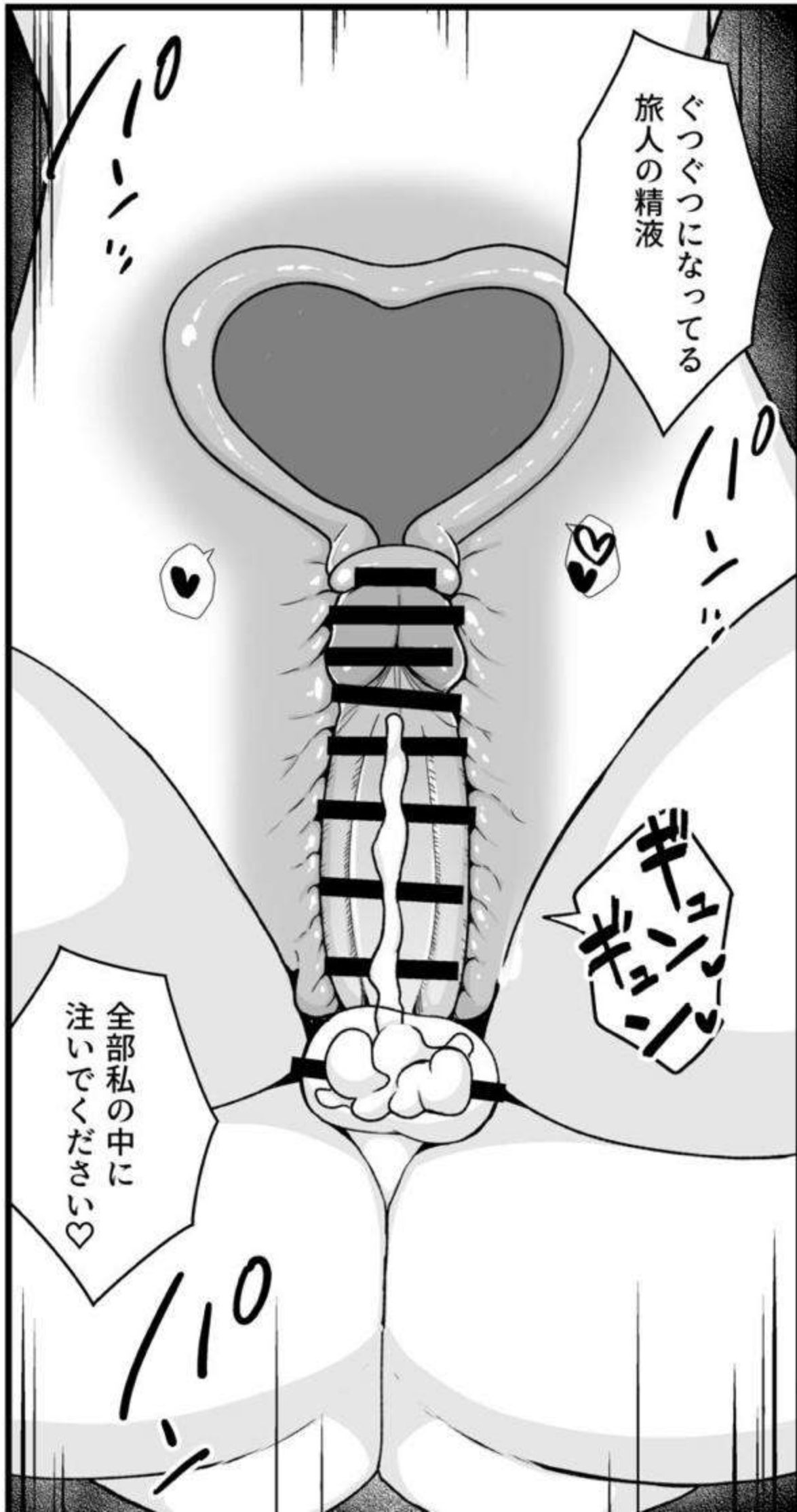

ぐっぐっになってる
旅人の精液

全部私の中に
注いでください♡

ギューン
ギューン



あ♡来て♡
来て♡ください♡

あ♡♡



もっと♡っぱら突いて♡





私はまだ
満足してませんけど…



続き…
しますか…？

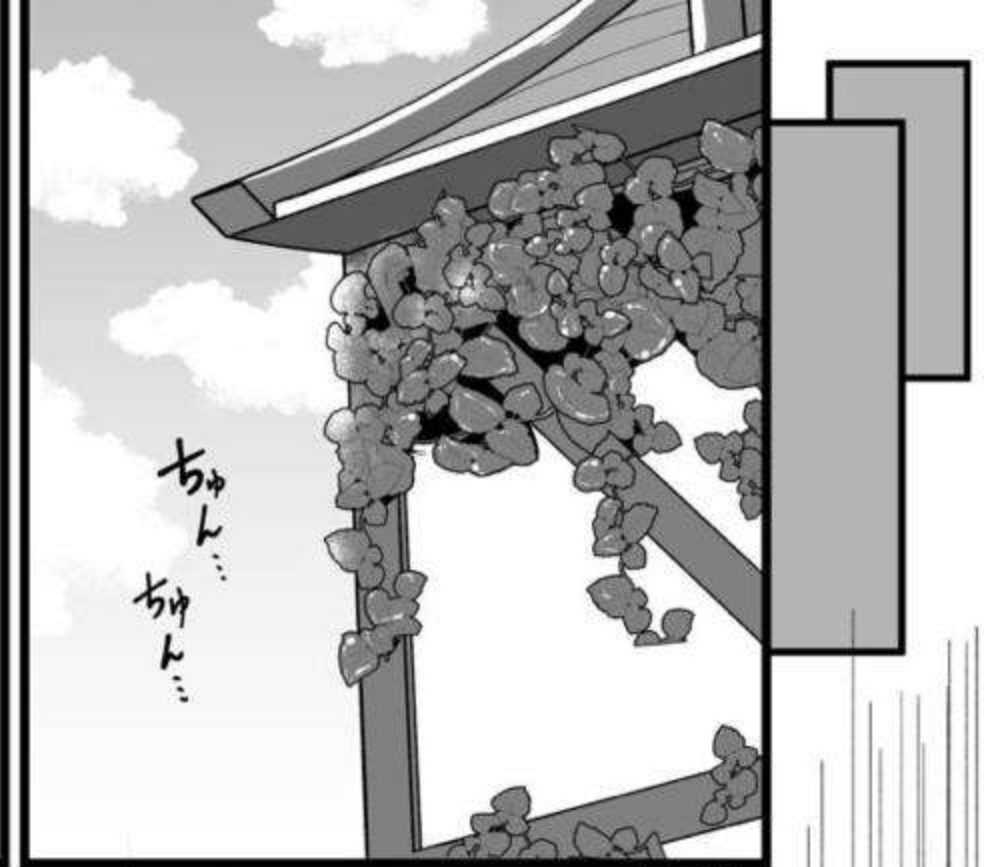



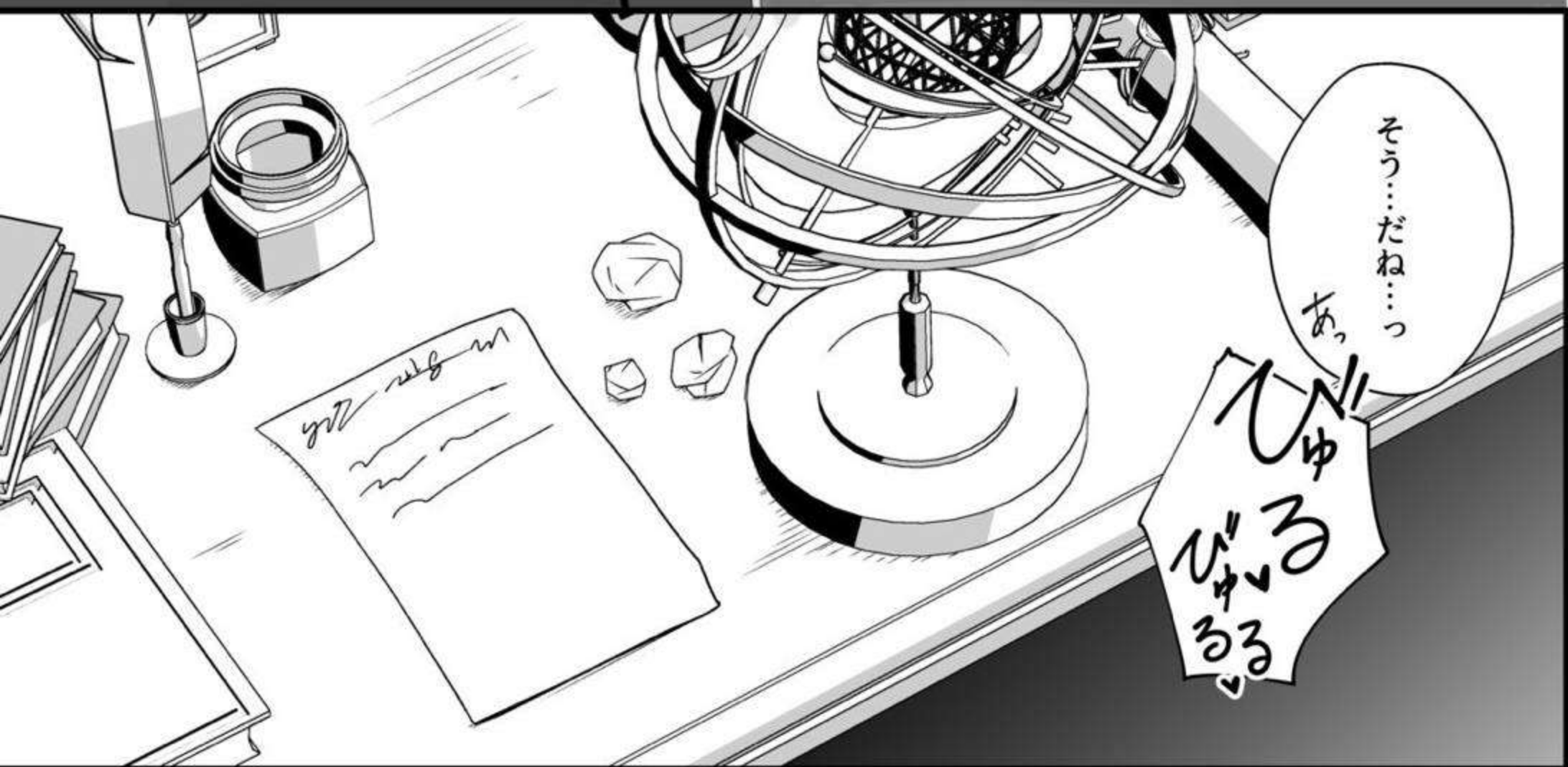

あとがき

本書をお手に取っていただき、誠にありがとうございます。
モナちゃんのお尻特化本でしたがいかがでしたでしょうか？
ドライハンプや尻コキなど作者の性癖のオンパレード
でしたが、楽しんでいただけたら幸いです。
モナの公式紹介動画をYoutubeで偶然見たのが原神を始める
きっかけだったので、やっと描くことができて大満足です。
原神本はネタのストックがまだまだあるので、今後も何らかの
形にしていきたいなと思ってます。錬金術に精液が必要で旅人
にお願いするスクロース、懺悔室で信者の性処理をするロサ
リア、100歳越えなのに実はまだ処女なファルザンとの初H等々…
アイデアは沢山あるのにそれを形にする時間と技術がないのが
もどかしい…。それでも絵が描けるうちはコツコツ続けて
いくと思うので、興味があればまた本を手にとっていただけると
嬉しいです。それでは、またどこかでお会いしましょう。

モナ尻へコへコ腰パンパン。

発行日 : 2024年8月1日
サークル名 : きききのきっき
発行者 : ゆずきいろ
Twitter : @yuzu_kiro
pixiv : @yuzu_kiro
印刷所 : トム出版



Twitter



pixiv

- この作品はフィクションです。実在の人物・作品・団体・出来事などには関係ありません。
- この本は個人が非公式に発行したものです。そのため、公式設定に準拠していません。
- 18歳未満の閲覧は禁止です。本書の転載、編集、トレース、転売、使用を禁止します。

●This is a work of fiction. Any resemblance to actual persons, living or dead, works, organizations, events, or locales is entirely coincidental.

●This work is an unofficial publication by a private individual.
It does not represent any official point of view.

●ADULTS ONLY 18+. DO NOT REPOST, EDIT, TRACE, RESELL OR USE MY WORKS.



きききのきつき

KIKIKI no KIKKI